

Daily Time Switch H5L

CSM_H5L_DS_E_2_3

Weekly Control with a Large Time Display



Easy Programming with Large Display and Interactive Functions.

- Easy operation with five keys.
- Up to 24 steps of ON/OFF operations can be set.
- Power supply freely selectable from 100 to 240 VAC.
- Memory protection during power failure for up to 10 years.
- Certified for UL and CSA safety standards.
- The same setting can be used for multiple-day operation and timer operation.

⚠ Refer to *Safety Precautions for All Timers*.
Refer to *Safety Precautions* on page 12



For the most recent information on models that have been certified for safety standards, refer to your OMRON website.

Ordering Information

Wiring	Backup power supply function for memory protection	No. of program steps	Model
Screw terminals	Provided (approx. 10 years at 25°C)	24 (Each ON or OFF is considered to be one step.)	H5L-A

Specifications

■ Time Ranges

Rated time	Time setting range	Time division
24 hrs x 7 days	00:00 to 23:59	1 min

■ Ratings

Rated supply voltage	100 to 240 VAC (50/60 Hz)
Operating voltage range	85% to 110% of rated supply voltage
Power consumption	Approx. 4 VA at 240 VAC
Control outputs	15 A at 250 VAC, resistive load at 50°C 12 A at 250 VAC, resistive load at 55°C Minimum applied load: 100 mA at 5 VDC (failure level: P, reference value)

■ Characteristics

Accuracy of operating time	±0.01% ±0.05 s max. (see note 1)
Setting error	
Influence of voltage	
Influence of temperature	
Time accuracy	±15 s per month (at 25°C)
Insulation resistance	100 MΩ min.
Dielectric strength	2,000 VAC, 50/60 Hz for 1 min (between current-carrying terminals and exposed non-current-carrying metal parts and between control power supply circuit and contact control output circuits) 1,000 VAC, 50/60 Hz for 1 min (between non-continuous contacts)
Vibration resistance	Destruction: 10 to 55 Hz with 0.75-mm double amplitude Malfunction: 10 to 55 Hz with 0.5-mm double amplitude
Shock resistance	Destruction: 300 m/s ² (approx. 30G) Malfunction: 100 m/s ² (approx. 10G)
Ambient temperature	Operating: -10°C to 55°C
Ambient humidity	Operating: 35% to 85%
Life expectancy	100,000 operations min. (15 A at 250 VAC, resistive load)
Degree of protection	IP-40 (Rear case: IP-20, Terminals: IP-00)
Weight	Approx. 350 g
Approved standards	UL917 CSA 22.2 No.14 Conforms to Electrical Appliance and Material Safety Law (for Japan) CCC: GB/T 14048.5 Pollution degree 2, Overvoltage category II (see note 2)

- Note:** 1. The overall error, which includes repeat accuracy, setting error, and variations due to changes in voltage and temperature, is ±0.01% or ±0.05 s max. The accuracy of ±0.01% also indicates the error in the time interval of the set time.
2. CCC certification requirements.

Recommended fuse	021702.5 (250 VAC, 15 A), manufactured by Littelfuse
Rated operating voltage U _e	AC-15: U _e : 250 VAC, I _e : 10 A
Rated operating current I _e	DC-13: U _e : 125 VAC, I _e : 15 A
Rated insulation voltage	250 V
Rated impulse withstand voltage (altitude: 2,000 m max.)	2.5 kV (at 240 VAC)
Conditional short-circuit current	1,000 A

Engineering Data

Ambient Operating Temperature and Carry Current

Note that the upper limit of the ambient operating temperature lowers when a large carry current is being applied as shown below.

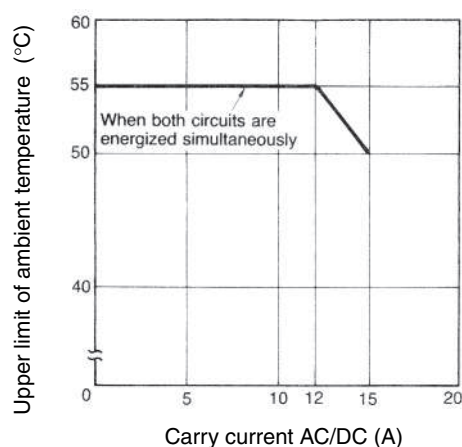

Nomenclature

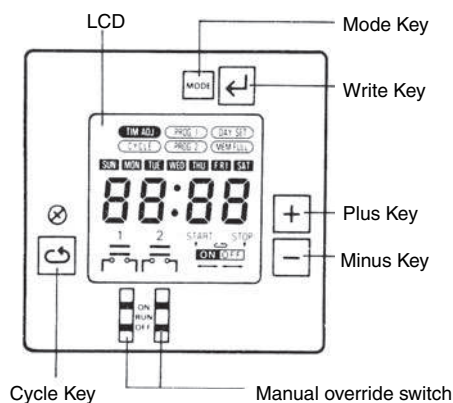

Note: This figure shows the LCD section with all display items being displayed on the screen.

Key Operation

Key	Name	Function
	Mode Key	Changes program mode <div style="text-align: center;"> </div>
	Write Key	To write the set data using the Plus and/or Minus Key. Reads out the set program.
	Plus Key	Changes "day of week" while setting day of week. Changes "hours" or "minutes" while setting current time. When the Plus Key is held down, the displayed digit increments continuously; when the Minus Key is held down, it decrements continuously.
	Minus Key	When specifying output. The Plus Key specifies output ON while the Minus Key specifies output OFF. Note that if the same key is pressed twice, the output specification becomes invalid; neither ON nor OFF is set.
	Cycle Key	Specifies the cycle program. Pressing this key twice causes the set cycle program to be cleared.
	Manual override switch	ON: Turns ON output regardless of program RUN: Executes program OFF: Turns OFF output regardless of program First and second circuit can be operated independently.

Operation

■ Programming

The H5L Weekly Timer has the following six program modes. Use the Mode Key to change the modes. Use the Write Key, Plus Key, Minus Key, and Cycle Key for programming in each mode.

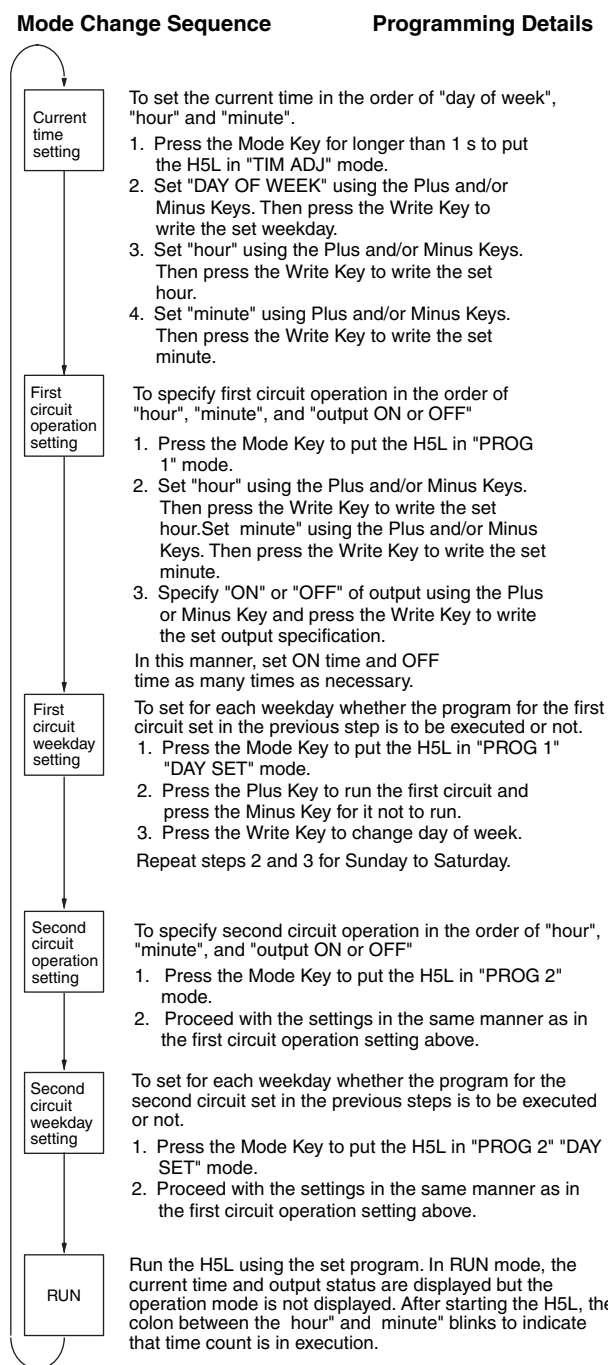

Note: The H5L operates in accordance with the program already set even while another program is being set. The output status display (ON/OFF etc.) during programming displays the setting being programmed. Therefore, note that the output status displayed on the LCD may not agree with the actual output status.

Setting Multiple-day Operation

Example for Turning ON Circuit 1 Every Day from Monday to Friday at 11:50 pm and Turning Circuit 1 OFF at 3:00 am the Next Morning

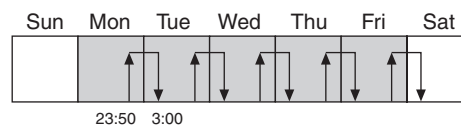

1. Use the procedure *First circuit operation setting* given at the left to set the ON time to 23:50 and the OFF time to 3:00.
2. Use the procedure *First circuit weekday setting* given at the left to set Monday, Tuesday, Wednesday, Thursday, and Friday.

Cycle Program

In the H5L, the cycle program can be used to repeat ON and OFF of output for a certain period in a predetermined cycle. A cycle program consists of the following four steps: Start time, ON time, OFF time, Stop time

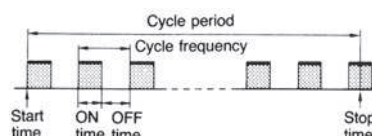

Setting A Cycle Program

Set the four steps of the cycle program in the following procedure.

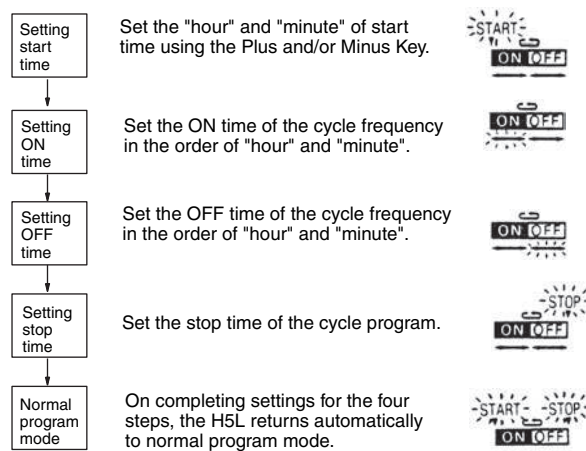

Cautions on Using Cycle Programs

1. When the current time is included within the set cycle period, the cycle operation starts (output turns ON) on completing the cycle program setting (when stop time is written).
2. When any of the following occurs during a cycle period, the cycle operation restarts from output ON.
 - Recovery after power failure
 - Current time adjustment
 - Change of start or stop time of the cycle program during operation.
 For this reason, if the cycle programs for the first and second circuits are set in such a manner that outputs 1 and 2 have a phase difference, note that the phase difference is changed when any of the conditions above occur as shown in the example below. (Therefore, it is recommended that cycle programs are used sequentially.)

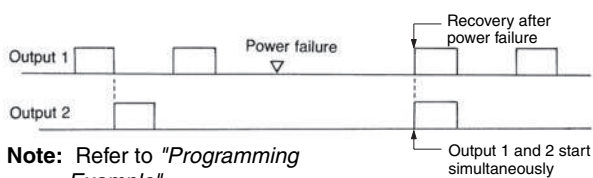

Note: Refer to "*Programming Example*".

3. The cycle period (from start time to stop time) does not need to be a multiple of the cycle frequency (ON time plus OFF time). The cycle period can be set within a range of 1 min to 24 hrs.
4. ON time as well as OFF time can be set within a range of 1 min to 23 hrs 59 min.

Deleting Programming

1. Deleting from Normal Operation Programs (ON Time/OFF Time)

Call up the output display for the program to be deleted by pressing the Write Key. The minus sign (-) for the output point will flash.

Next, change the display to disable the output using the Plus and Minus Keys. For NC contacts, press the Plus Key and for NO contacts, press the Minus Key. The connecting bar above the contacts will disappear and the display will flash to indicate that the output has been displayed. If the Write Key is pressed at this time, the step will be deleted.

2. Deleting from Cyclic Programs

Four steps will be simultaneously deleted from the cyclic program if the program is called up and then the Cycle and Write Keys are pressed in order. The start time display will remain, but the program will be deleted.

LCD Display

LCD Display (Display Example in Each Mode)

Since the H5L employs interactive programming, the program mode and setting data are displayed on the LCD.

Display	Mode	Display data	Display	Mode	Display data
	RUN	Current day of week: Monday Current time: 10:11 First circuit: OFF Second circuit: ON		Second operation time setting	The second circuit turns ON Sunday to Thursday (operation by the set program is executed). It turns OFF on Friday and Saturday (operation by the set program stops).
	Current time setting	Current day of week: Tuesday Current time: 9:31		Second Weekday setting	The second circuit turns ON Sunday to Thursday (operation by the set program is executed). It turns OFF on Friday and Saturday (operation by the set program stops).
	First operation time setting	The first circuit turns on at 8:15		Cycle Program setting	The first circuit starts cycle operation at 1:10 (for details, refer to Cycle Program).
	First weekday setting	The first circuit turns OFF on Sunday and Saturday (operation by the set program stops). It turns ON Monday to Friday (operation by the set program is executed).		Memory over	Indicates that all 24 program steps have been written (on writing the 24th step, the data set for the first step is displayed on the LCD).

Note: Meaning of output status indications

:Output ON, ; Output OFF, : Invalid (if an invalid instruction is written to a step, that step will be cleared.)

Programming Example

Be sure to create a timing chart before programming.

Operating Timing Chart

First Circuit

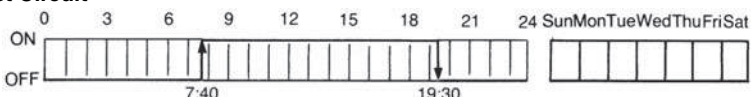

Second Circuit

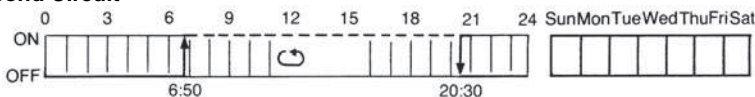

Example

ON and OFF Programs Cyclic Programs

In this example, the first circuit is programmed to turn ON at 7:40 and OFF at 19:30. This circuit is operated from Monday through Friday and stopped on Saturday and Sunday.

The second circuit is cyclically operated with each parameter set as follows:

Start time: 6:50
ON time: 5 min
OFF time: 20 min
Stop time: 20:30

The second circuit is stopped from operating on Sunday and operated from Monday through Saturday. The current time is assumed to be 11:15 a.m. on Tuesday.

Writing Program

Even while being programmed, the timer generates output according to the previous program. If you don't want an unexpected operation of output relay, turn on (or off) the manual switch.

In the figure, the indicators and digits shown in are blinking.

1. Setting Current Time



To set the current time, "day of the week", "hour", and "minute" must be specified.
First, turn on the power to the H5L.
The contents of the memory are cleared on power-up and the TIM ADJ indicator is displayed as shown on the left. As an example, set the time to 11:15 on Tuesday.



Start by setting the day of the week. The blinking indicator indicates the parameter that can be set. Set the current day of the week to Tuesday by pressing the Plus or Minus Key.



When "TUE" is displayed, press the Write Key to store the current day of the week in memory. The "hour" indicator will begin to flash and the "day of the week" indicator will stop flashing.



Set the current hour to 11 by pressing the Plus or Minus Key, followed by the Write Key.



At this time, the "minute" indicator will blink. Set the current minute to 15 by pressing the Plus or Minus Key, followed by the Write Key.



This completes the current time setting.

2. First Circuit Operation Setting



To program the operation of the first circuit, "hour", "minute", and "output" must be specified. Press the Mode Key to place the H5L into PROG 1 mode. The display will be as shown on the left.



Since the first circuit is to be turned ON at 7:40, set the "hour" to 7 by pressing the Plus or Minus Key and then store it in memory by using the Write Key.



The "minute" will start blinking. Set it to 40 by using the Plus or Minus Key and store it in memory by pressing the Write Key.



Now, the output status indicator will blink. Set the output to the ON state with the Plus Key followed by the Write Key.
(If the Plus Key is pressed twice at this time, the display will give an invalid indication, and if the Write Key is pressed, this program will be deleted.)

The display returns to the initial state as shown on the left and waits for the next program command to be input.



Since the first circuit should be turned OFF at 19:30, set the hour to 19 and the minute to 30 by using the Plus or Minus Key and then the Write Key.



The output status indicator starts blinking. Set the output to the OFF state using the Minus Key and store it in memory by pressing the Write Key.



The display returns to the initial state and waits for the next program command to be input. Now let us turn to the setting of the "day of the week".



3. First Circuit Day-of-the-week Setting

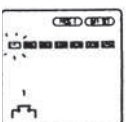

By pressing the Mode Key, place the H5L into DAY SET mode. The display will be as shown on the left. Press the Plus Key to operate the first circuit on a particular day of the week and press the Minus Key to stop it. The reverse video (i.e., white characters on a black background) of the day-of-the-week indicators means that the first circuit is operated on that day. The day on which circuit operation is stopped is indicated by bold indicators. Initially, the circuit is set to operate on all the days of the week and the SUN indicator blinks.

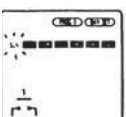

In this example, since circuit operation is to be stopped on Sunday, select SUN and press the Minus Key, then store the setting in memory by pressing the Write Key.

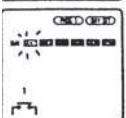

The MON indicator will start blinking. Press the Write Key, until the SAT indicator blinks.

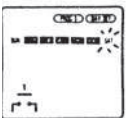

Since the first circuit is not to be operated on Saturday, press the Minus Key followed by the Write Key.

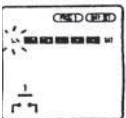

The SUN indicator will start blinking again. This completes the setting of all the days of the week for the first circuit.

4. Second Circuit Operation Setting



Press the Mode Key to place the H5L into PROG 2 mode. The display appears as shown on the left.



In this example, as the second circuit is to be cyclically operated, specify the cycle program by pressing the Cycle Key.



Select the start time by setting the hour to 6 and the minute to 50 using pressing the Plus or Minus Key. Write each set value by pressing the Write Key.



The timer will now wait for you to set the ON time (5 min in this example).

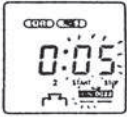

Press the Write Key to select 0 hrs, then use the Plus or Minus Keys followed by the Write Key to select 5 min.



The timer will now wait for the OFF time to be set (20 min in this example).



Press the Write Key to select 0 hrs, then use the Plus or Minus Keys followed by the Write Key to select 20 min.



The timer will now wait for the cyclic circuit operation stop time to be set (20:30 in this example).



Set the hour to 20 using the Plus or Minus Keys, then press the Write Key. Set the minutes to 30 and press the Write Key again.



The programming of the cyclic operation is now complete. The timer will wait for input of a new program as shown. We will now have to set the day of the week for the second circuit.

5. Second Circuit Day-of-the-Week Setting

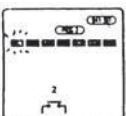

Press the Mode Key to place the H5L into PROG 2, DAY WET mode. Initially, all days of the week are selected (shown by reverse video) and the SUN indicator will be flashing.

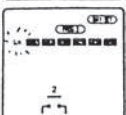

In our example, the second circuit is to be operated on all days except Sunday. To inhibit Sunday operation, press the Minus Key while the SUN indicator is flashing. The circuit will now be operated only from Monday to Saturday.



All of the parameters have now been programmed for this example. Press the Mode Key to place the timer into RUN mode. The display will be as shown (assuming five minutes have elapsed while programming). The output status indicators indicate the status of each of the circuit.

Note: Set manual override switches 1 and 2 to RUN.

Dimensions

Note: All units are in millimeters unless otherwise indicated.

H5L-A

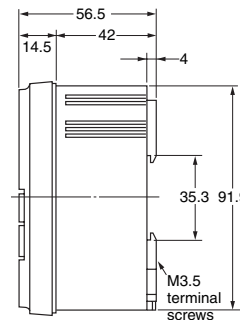
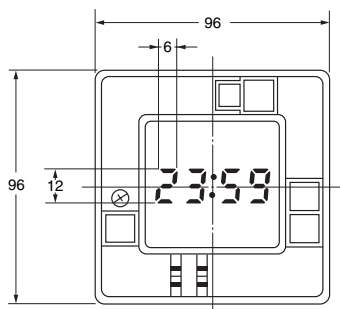
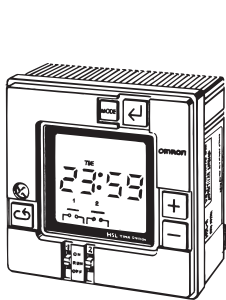

Dimensions

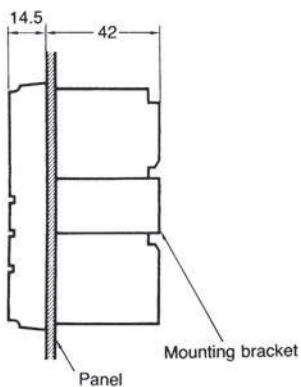

Panel Cutout

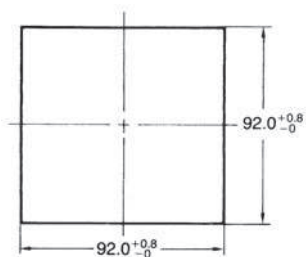

Mounting Bracket (Included)



Dimensions

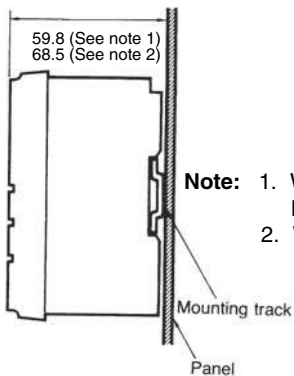

- Note:**
1. When using mounting track PFP-100N or PFP-50N.
 2. When using mounting track PFP-100N2.

Panel Cutout

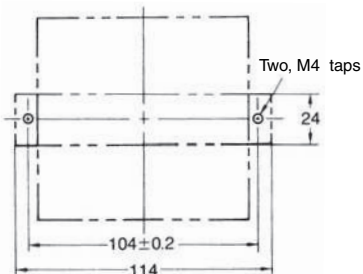

Mounting Bracket (Included)



Dimensions

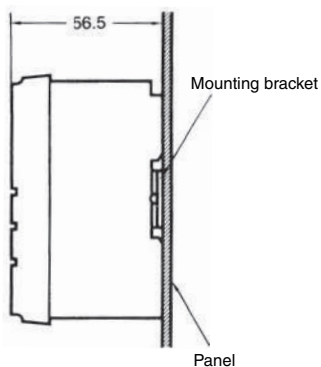

■ Accessories (Order Separately)

Front Cover Y92A-96A

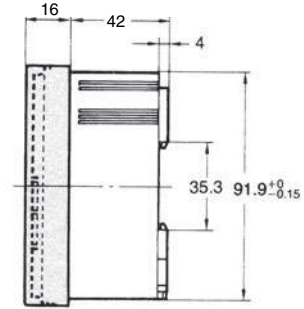
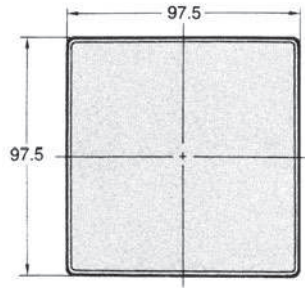

Mounting Track (Meets DIN EN 50022) PFP-100N/PFP-50N

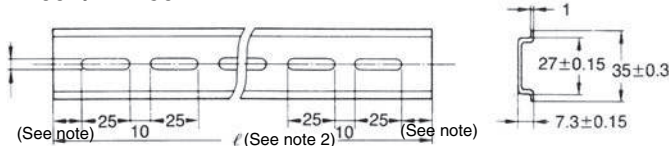

- Note:**
1. This dimension is 15 mm on both ends in the case of the PFP-100N but on one end in the case of the PFP-50N.
 2. The length l of each mounting track is shown in this table.
 3. A total of twelve 25×4.5 elliptic holes are provided, with six holes cut from each end of the track at a pitch of 10 mm between holes.

PFP-100N2

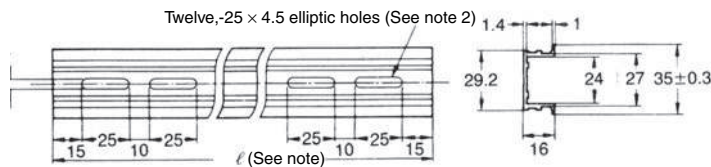

PFP-100N	1 m
PFP-50N	50 cm
PFP-100N2	1 m

Installation

■ Connections

Connect the power supply between terminals ① and ②, the load for the first circuit between terminals ⑦ and ⑧, and the load for the second circuit between terminals ⑤ and ⑥. Terminals ③ and ④ are no connects.

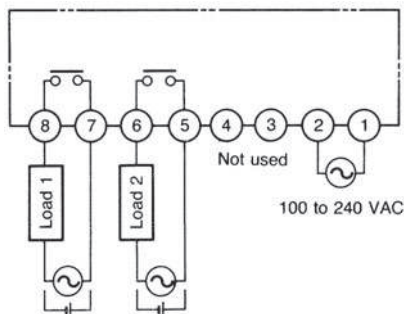

Note: To each load, connect the power supply for load.

Safety Precautions

Refer to *Safety Precautions for All Timers*.

CAUTION

Tighten terminal screws to the specified torque of approx. 0.8 N·m (maximum torque: 0.98 N·m). Loose screws may occasionally cause fires or malfunction.



The Time Switch contains a lithium battery (explosion-proof). Do not disassemble the Time Switch, deform the Time Switch under pressure, heat the Time Switch to above 100°C, or incinerate the Time Switch. Doing any of these may result in fire or battery rupture.



Precautions for Safe Use

Observe all of the following precautions to maintain safety.

1. The Time Switch is not waterproof or oil resistant. Do not use it in locations subject to water or oil.
2. Use the following wire to wire the Time Switch: 600-V vinyl-insulated wire (solid wire or twisted wire, copper), 14 to 24 AWG. The recommended stripping length is 5 to 6 mm.
3. Do not connect more than two crimp terminals to each Time Switch terminal.
4. None of the Time Switch components are user-replaceable, including the battery.

Precautions for Correct Use

Be sure that the capacity of the power supply is large enough, otherwise the Time Switch may not start due to the inrush current (approx. 3 A) that flows for an instant when the power to the Time Switch is turned ON.

ON Current and Ambient Temperature (Reference Values)

If the ON current is too large, the upper limit to the ambient operating temperature must be reduced as shown in the following diagram.

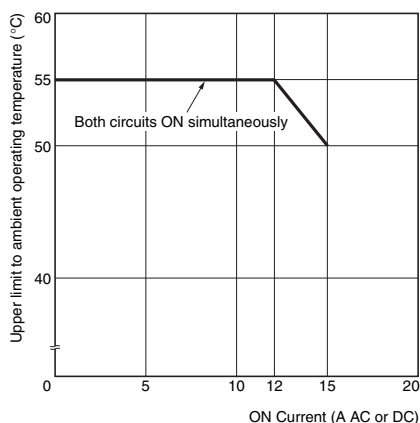

Mounting Dimensions

Flush Mounting

- Use a U-shaped mounting bracket to flush mount the unit.

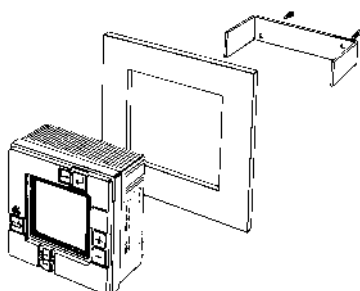

Surface Mounting

- Use a straight mounting bracket to surface mount the unit.

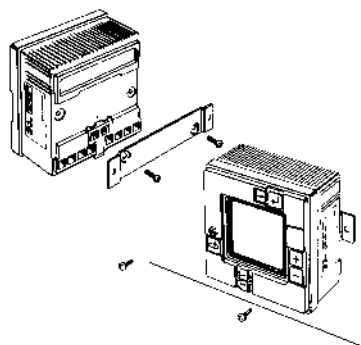

Track Mounting

- Hook the upper part on the rear surface to the upper edge of the mounting track and press the unit down.

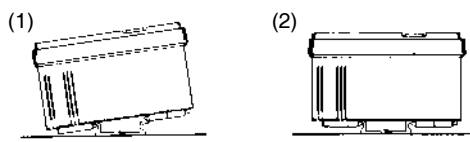

- To remove the Timer Switch from the DIN Track, pull down on the yellow lever at the back of the Timer Switch.

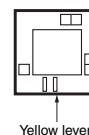

Wiring

Wiring From the Rear

- Perform wiring from the rear of the unit when the unit is flush mounted.

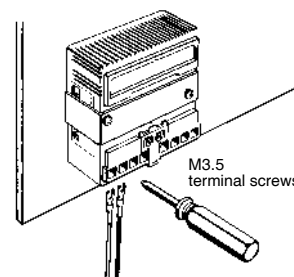

Wiring From the Front

- Perform wiring from the front of the unit when the unit is track or surface mounted.

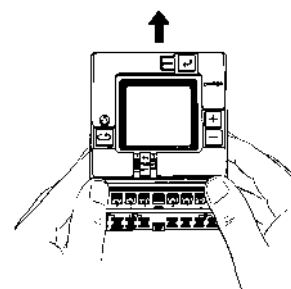

Wiring Procedure

1. Loosen the screw on the left side of the front.
2. Slide the upper part of the unit approx. 15 mm upward.
3. After the terminals appear, perform wiring.
4. Return the upper part of the unit to the original position and tighten the screw.

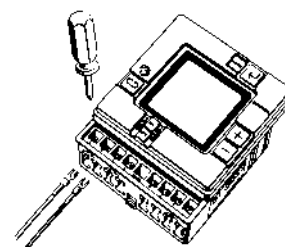

Note: Screw tightening torque: 0.98 N·m max.

ALL DIMENSIONS SHOWN ARE IN MILLIMETERS.
To convert millimeters into inches, multiply by 0.03937. To convert grams into ounces, multiply by 0.03527.

In the interest of product improvement, specifications are subject to change without notice.

Terms and Conditions Agreement

Read and understand this catalog.

Please read and understand this catalog before purchasing the products. Please consult your OMRON representative if you have any questions or comments.

Warranties.

(a) Exclusive Warranty. Omron's exclusive warranty is that the Products will be free from defects in materials and workmanship for a period of twelve months from the date of sale by Omron (or such other period expressed in writing by Omron). Omron disclaims all other warranties, express or implied.

(b) Limitations. OMRON MAKES NO WARRANTY OR REPRESENTATION, EXPRESS OR IMPLIED, ABOUT NON-INFRINGEMENT, MERCHANTABILITY OR FITNESS FOR A PARTICULAR PURPOSE OF THE PRODUCTS. BUYER ACKNOWLEDGES THAT IT ALONE HAS DETERMINED THAT THE PRODUCTS WILL SUITABLY MEET THE REQUIREMENTS OF THEIR INTENDED USE.

Omron further disclaims all warranties and responsibility of any type for claims or expenses based on infringement by the Products or otherwise of any intellectual property right. (c) Buyer Remedy. Omron's sole obligation hereunder shall be, at Omron's election, to (i) replace (in the form originally shipped with Buyer responsible for labor charges for removal or replacement thereof) the non-complying Product, (ii) repair the non-complying Product, or (iii) repay or credit Buyer an amount equal to the purchase price of the non-complying Product; provided that in no event shall Omron be responsible for warranty, repair, indemnity or any other claims or expenses regarding the Products unless Omron's analysis confirms that the Products were properly handled, stored, installed and maintained and not subject to contamination, abuse, misuse or inappropriate modification. Return of any Products by Buyer must be approved in writing by Omron before shipment. Omron Companies shall not be liable for the suitability or unsuitability or the results from the use of Products in combination with any electrical or electronic components, circuits, system assemblies or any other materials or substances or environments. Any advice, recommendations or information given orally or in writing, are not to be construed as an amendment or addition to the above warranty.

See <http://www.omron.com/global/> or contact your Omron representative for published information.

Limitation on Liability: Etc.

OMRON COMPANIES SHALL NOT BE LIABLE FOR SPECIAL, INDIRECT, INCIDENTAL, OR CONSEQUENTIAL DAMAGES, LOSS OF PROFITS OR PRODUCTION OR COMMERCIAL LOSS IN ANY WAY CONNECTED WITH THE PRODUCTS, WHETHER SUCH CLAIM IS BASED IN CONTRACT, WARRANTY, NEGLIGENCE OR STRICT LIABILITY.

Further, in no event shall liability of Omron Companies exceed the individual price of the Product on which liability is asserted.

Suitability of Use.

Omron Companies shall not be responsible for conformity with any standards, codes or regulations which apply to the combination of the Product in the Buyer's application or use of the Product. At Buyer's request, Omron will provide applicable third party certification documents identifying ratings and limitations of use which apply to the Product. This information by itself is not sufficient for a complete determination of the suitability of the Product in combination with the end product, machine, system, or other application or use. Buyer shall be solely responsible for determining appropriateness of the particular Product with respect to Buyer's application, product or system. Buyer shall take application responsibility in all cases.

NEVER USE THE PRODUCT FOR AN APPLICATION INVOLVING SERIOUS RISK TO LIFE OR PROPERTY OR IN LARGE QUANTITIES WITHOUT ENSURING THAT THE SYSTEM AS A WHOLE HAS BEEN DESIGNED TO ADDRESS THE RISKS, AND THAT THE OMRON PRODUCT(S) IS PROPERLY RATED AND INSTALLED FOR THE INTENDED USE WITHIN THE OVERALL EQUIPMENT OR SYSTEM.

Programmable Products.

Omron Companies shall not be responsible for the user's programming of a programmable Product, or any consequence thereof.

Performance Data.

Data presented in Omron Company websites, catalogs and other materials is provided as a guide for the user in determining suitability and does not constitute a warranty. It may represent the result of Omron's test conditions, and the user must correlate it to actual application requirements. Actual performance is subject to the Omron's Warranty and Limitations of Liability.

Change in Specifications.

Product specifications and accessories may be changed at any time based on improvements and other reasons. It is our practice to change part numbers when published ratings or features are changed, or when significant construction changes are made. However, some specifications of the Product may be changed without any notice. When in doubt, special part numbers may be assigned to fix or establish key specifications for your application. Please consult with your Omron's representative at any time to confirm actual specifications of purchased Product.

Errors and Omissions.

Information presented by Omron Companies has been checked and is believed to be accurate; however, no responsibility is assumed for clerical, typographical or proofreading errors or omissions.